

40A,100V Schottky Barrier Rectifier

Features

- Ultra low forward voltage, low power loss
- Low leakage current
- High surge current
- Plastic package has underwriters Laboratory Flammability Classification 94V-0
- Halogen-free according to IEC 61249-2-21

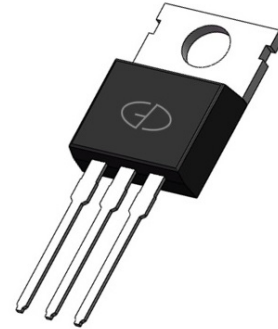

TO-220AB

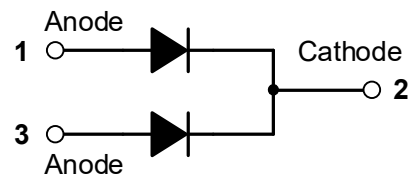

Applications

- SMPS
- Adapter
- Server Power

Mechanical Data

- Case: Epoxy, Molded
- Finish: All External Surfaces Corrosion Resistant and Terminal Leads are Readily Solderable
- Lead Temperature for Soldering Purposes: 260°C Max. for 10 sec
- Shipped 50 units per plastic tube

Maximum Ratings & Electrical Characteristics (TA=25°C unless otherwise noted)

| Parameter | Symbol | SBR40100CT | Unit |
|--|--------|-------------|------|
| Maximum repetitive peak reverse voltage | VRRM | 100 | V |
| Maximum RMS voltage | VRMS | 70 | V |
| Maximum DC blocking voltage | VDC | 100 | V |
| Maximum average forward | IF(AV) | 40 | A |
| Peak forward surge current, 8.3ms single half sine-wave superimposed on rated load per diode | IFSM | 200 | A |
| Operating junction temperature range | TJ | -55 to +150 | °C |
| Storage temperature range | TSTG | -55 to +150 | °C |

| Electrical Specifications (T _A =25°C unless otherwise noted) | | | | | |
|---|----------------|--|------|------|------|
| Parameter | Symbol | Test Conditions | Typ | Max | Unit |
| Forward drop voltage (Note1) | V _F | I _F =20A, T _J =25°C | 0.62 | 0.66 | V |
| | | I _F =20A, T _J =125°C | - | 0.59 | |
| | | I _F =40A, T _J =25°C | - | - | |
| | | I _F =40A, T _J =125°C | - | - | |
| Reverse leakage current @V _R (Note2) | I _R | T _J =25°C | - | 200 | uA |
| | | T _J =100°C | - | 15 | mA |

| Thermal-Mechanical Specifications (T _A =25°C unless otherwise noted) | | | |
|---|------------------|------|------|
| Parameter | Symbol | Typ | Unit |
| Thermal Resistance, Junction to Case | R _{θJC} | 2.0 | °C/W |
| Thermal Resistance, Junction to Ambient | R _{θJA} | 62.5 | °C/W |

Note:

1. Pulse test with PW=0.3ms, duty cycle=2%
2. Pulse test with PW=30ms

Ratings and Characteristics Curves

(TA = 25°C unless otherwise noted)

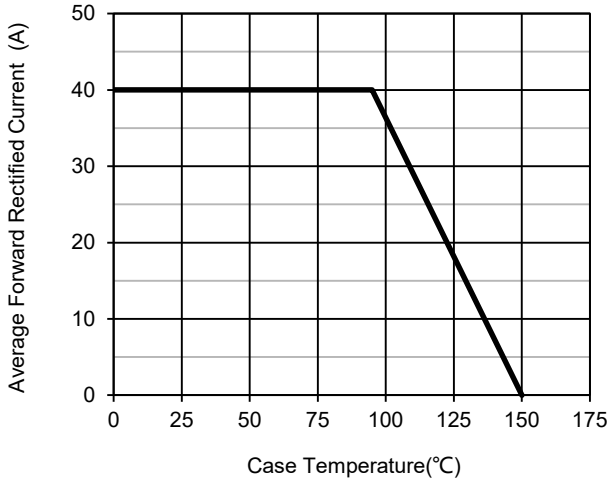

Fig.1 – Forward Current Derating Curve

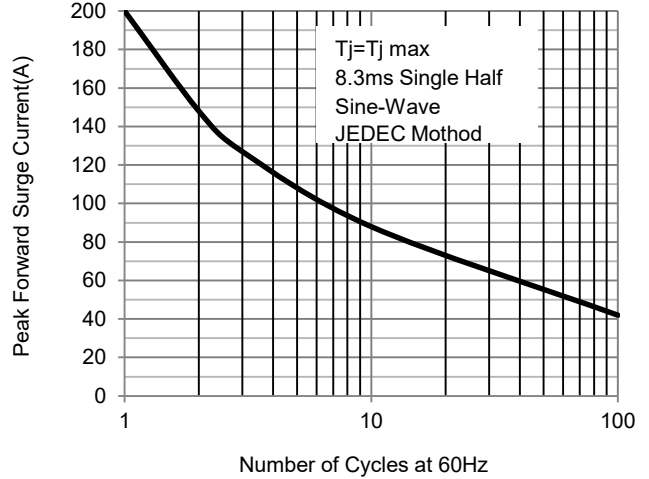

Fig.2 – Maximum Non-Repetitive Surge Current

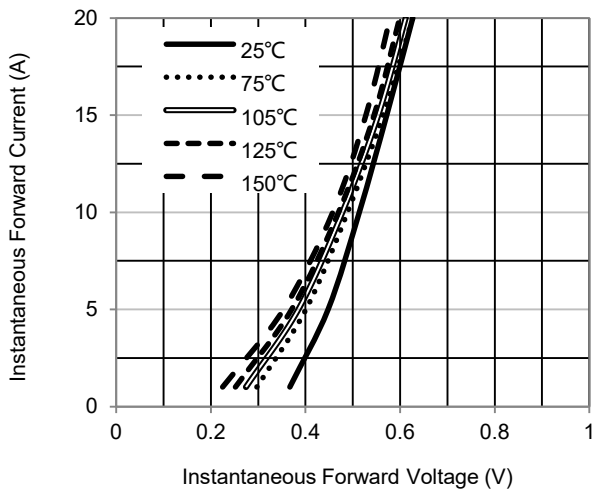

Fig.3 – Typical Forward Voltage Characteristics

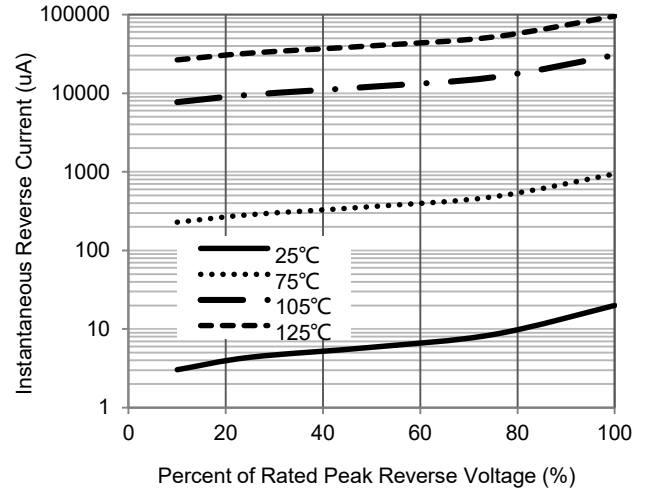

Fig.4 – Typical Reverse Current Characteristics

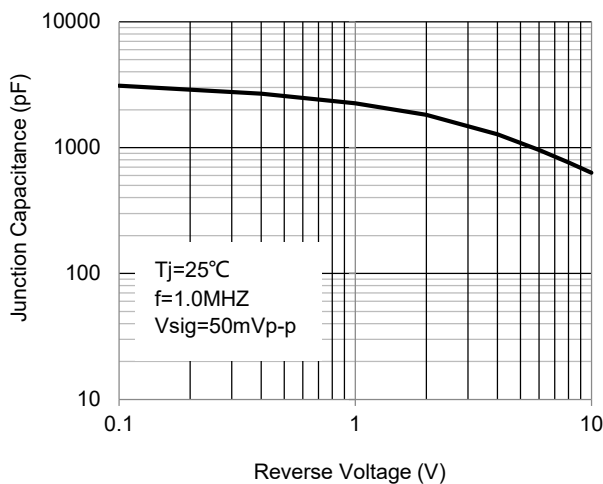
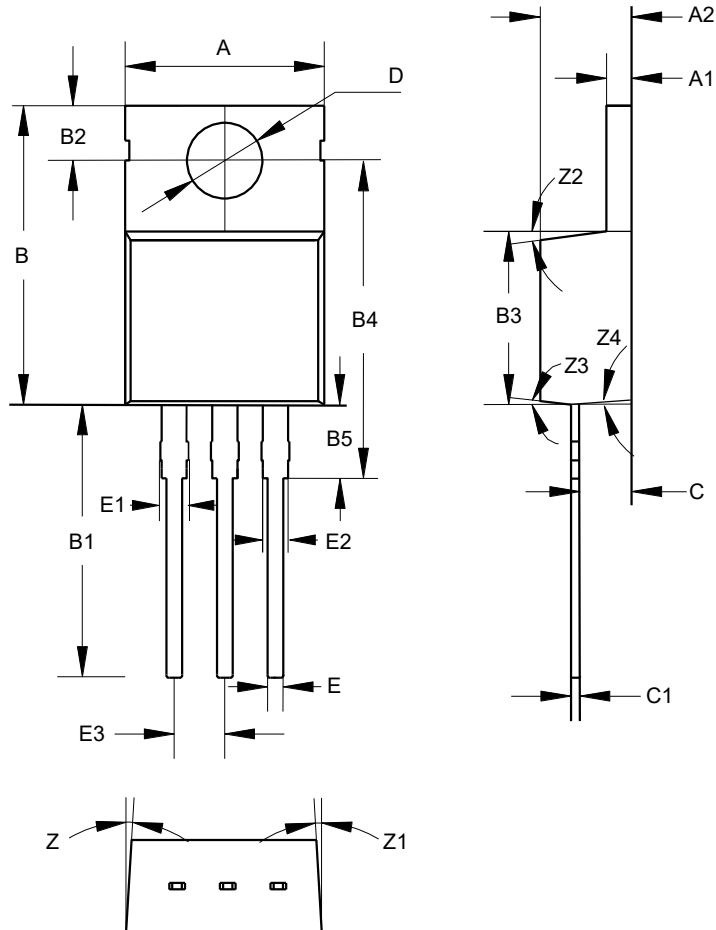

Fig.5 – Typical Junction Capacitance

Package Outline Dimensions (Unit: millimeters)

TO-220AB



| TO-220AB | | | | | | | |
|----------|------|------|------|----|------|------|------|
| | Min. | Nom. | Max. | | Min. | Nom. | Max. |
| A | 9.8 | 10 | 10.2 | D | 3.7 | 3.8 | 3.9 |
| A1 | 1.17 | 1.27 | 1.37 | E | 0.68 | 0.78 | 0.88 |
| A2 | 4.5 | 4.6 | 4.7 | E1 | 1.2 | 1.4 | 1.6 |
| B | 14.5 | 15 | 15.5 | E2 | 1.17 | 1.27 | 1.37 |
| B1 | 13.2 | 13.7 | 14.2 | E3 | 2.44 | 2.54 | 2.64 |
| B2 | 2.65 | 2.75 | 2.85 | Z | | 3° | |
| B3 | 8.5 | 8.7 | 8.9 | Z1 | | 3° | |
| B4 | 15.5 | 16 | 16.5 | Z2 | | 7° | |
| B5 | 3.4 | 3.7 | 4.0 | Z3 | | 7° | |
| C | 2.3 | 2.6 | 2.9 | Z4 | | 1.5° | |
| C1 | 0.28 | 0.38 | 0.48 | | | | |

Marking Outline

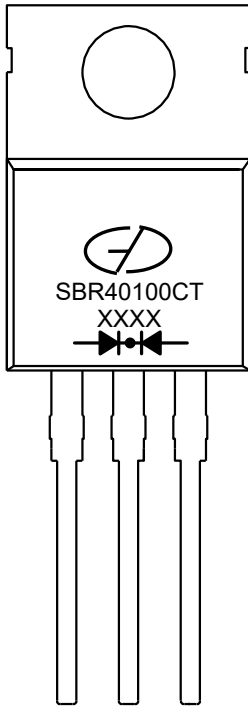

1. Logo Mark: 
2. Part Name: SBR40100CT
3. Date Code: XXXX
4. Polarity : 

Revision History

| Document Version | Date of release | Description of changes |
|------------------|-----------------|---|
| Rev.A | 2014.11.10 | Released Datasheet |
| Rev.B | 2021.01.13 | Modify document format |
| Rev.C | 2022.04.29 | Modify ratings and characteristics curves |

Disclaimers

These materials are intended as a reference to assist our customers in the selection of the Suzhou Good-Ark product best suited to the customer's application; they do not convey any license under any intellectual property rights, or any other rights, belonging to Suzhou Good-Ark Electronics Co., Ltd. or a third party.

Suzhou Good-Ark Electronics Co., Ltd. assumes no responsibility for any damage, or infringement of any third-party's rights, originating in the use of any product data, diagrams, charts, programs, algorithms, or circuit application examples contained in these materials.

All information contained in these materials, including product data, diagrams, charts, programs and algorithms represents information on products at the time of publication of these materials, and are subject to change by Suzhou Good-Ark Electronics Co., Ltd. without notice due to product improvements or other reasons. It is therefore recommended that customers contact Suzhou Good-Ark Electronics Co., Ltd. or an authorized Suzhou Good-Ark Electronics Co., Ltd. for the latest product information before purchasing a product listed herein. The information described here may contain technical inaccuracies or typographical errors. Suzhou Good-Ark Electronics Co., Ltd. assumes no responsibility for any damage, liability, or other loss rising from these inaccuracies or errors. Please also pay attention to information published by Suzhou Good-Ark Electronics Co., Ltd. by various means, including our website home page.

(<http://www.goodark.com>)

When using any or all of the information contained in these materials, including product data, diagrams, charts, programs, and algorithms, Please be sure to evaluate all information as a total system before making a final decision on the applicability of the information and products. Suzhou Good-Ark Electronics Co., Ltd. assumes no responsibility for any damage, liability or other loss resulting from the information contained herein.

The prior written approval of Suzhou Good-Ark Electronics Co., Ltd. is necessary to reprint or reproduce in whole or in part these materials.

Please contact Suzhou Good-Ark Electronics Co., Ltd. or an authorized distributor for further details on these materials or the products contained herein.